

HACKER A30-16M BRUSHLESS MOTOR OR EQUIVALENT. MOUNT WITH 2° RIGHT-THRUST

EDGE 5407

A SPORT/3D AEROBATIC FOAMIE FOR BRUSHLESS MOTORS AND 3S Li-Po PACKS, DESIGNED BY DAVE ROYDS

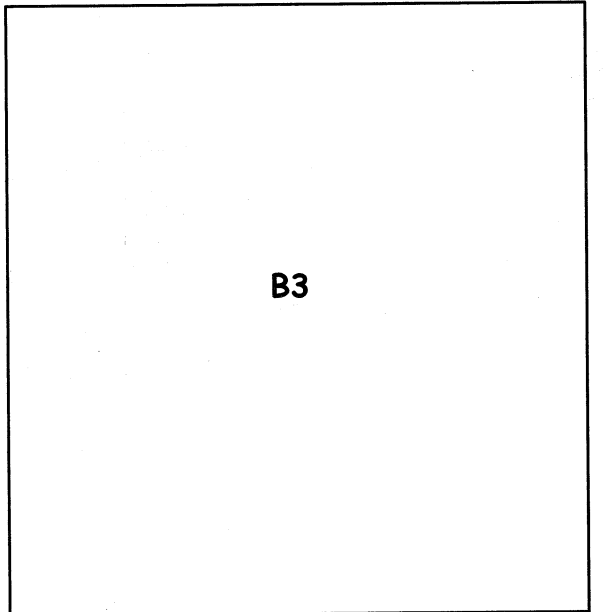
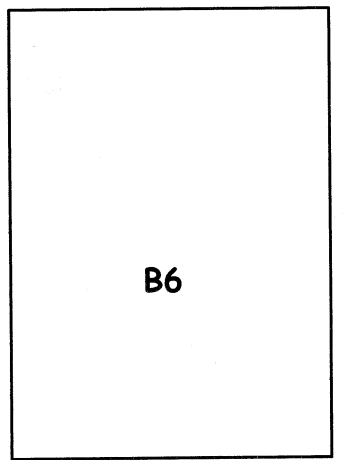
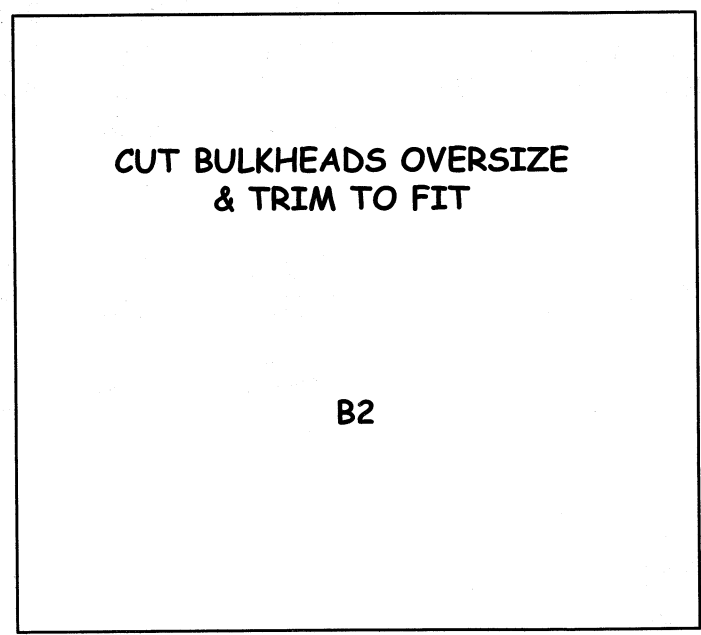
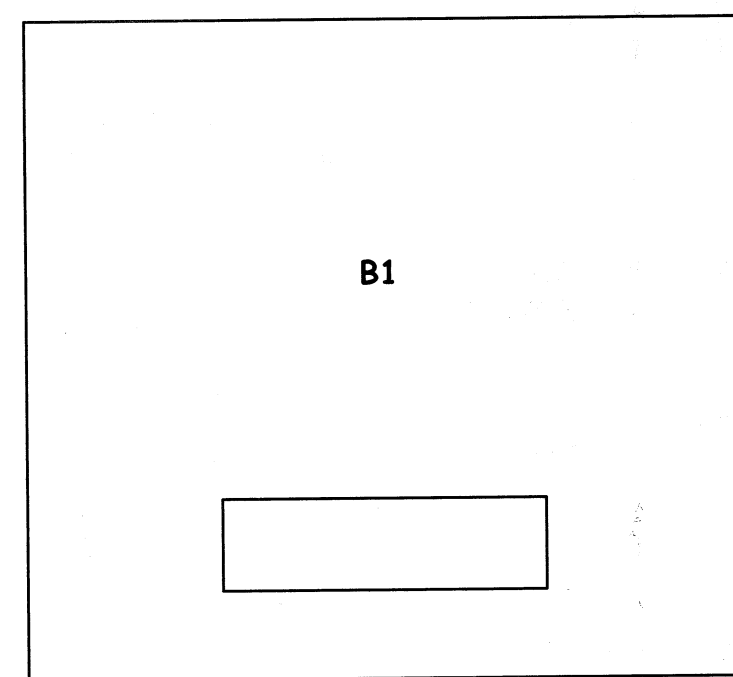
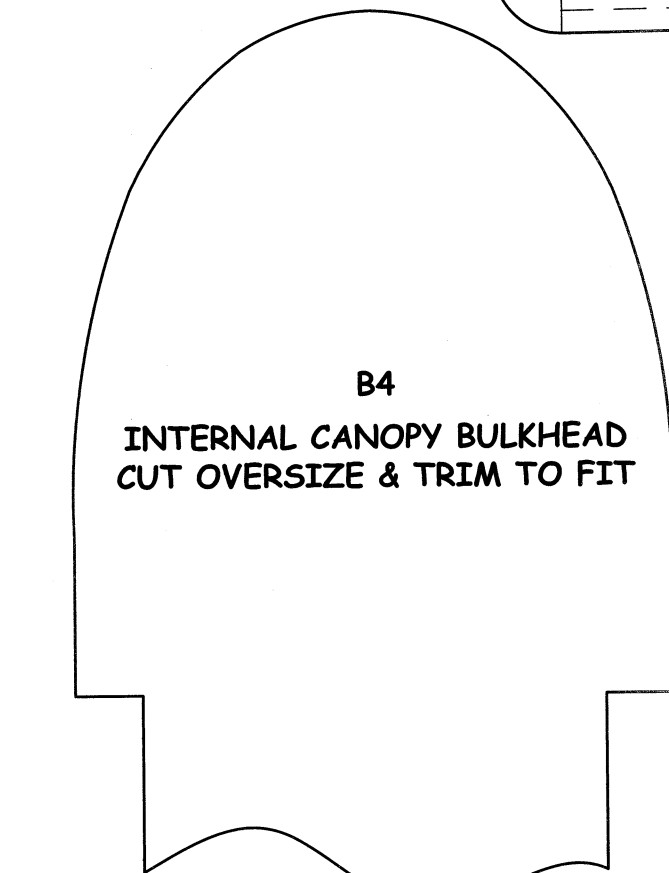
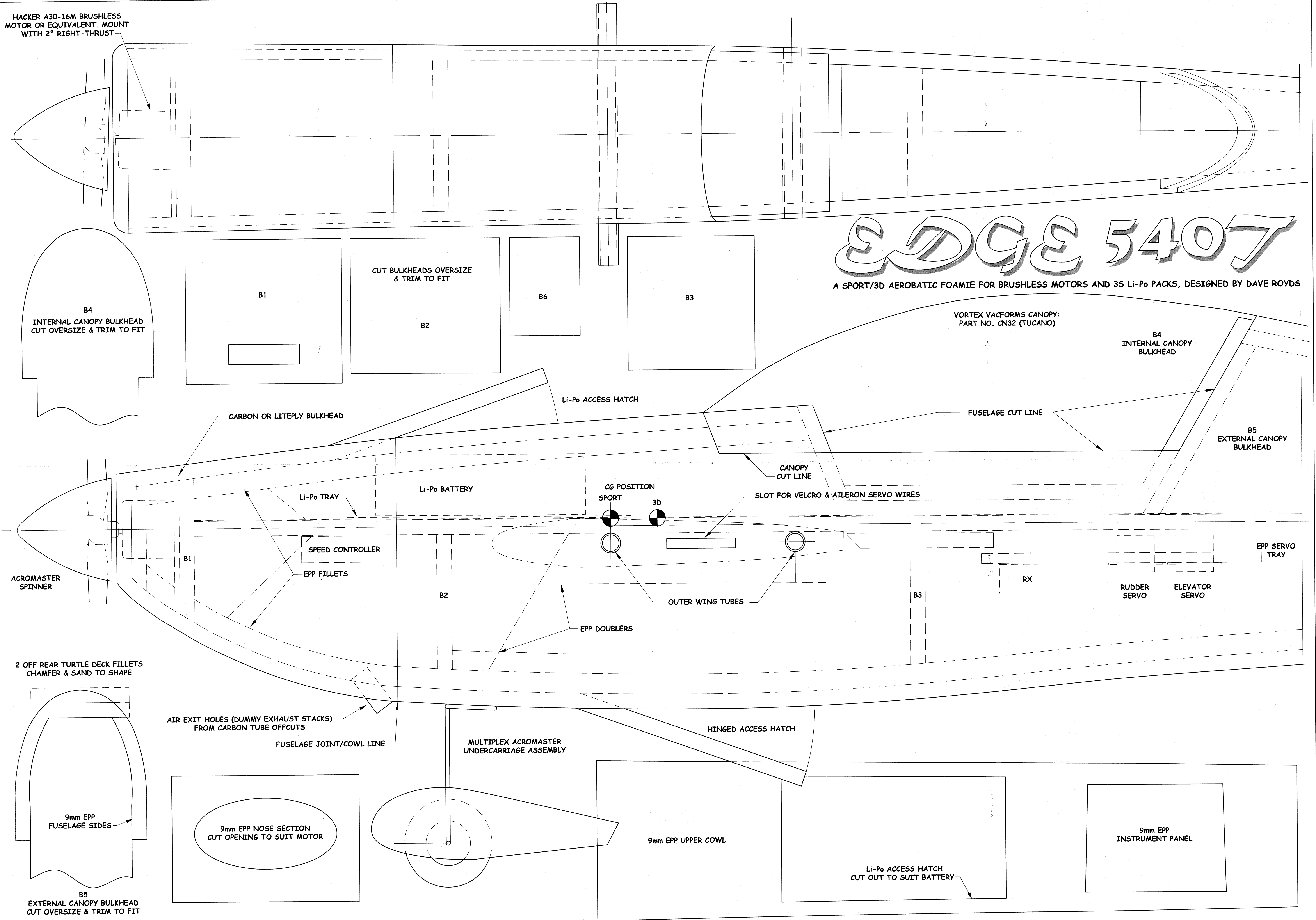

VORTEX VACFORMS CANOPY:
PART NO. CN32 (TUCANO)

B4
INTERNAL CANOPY
BULKHEAD

B5
EXTERNAL CANOPY
BULKHEAD

Li-Po ACCESS HATCH

FUSELAGE CUT LINE

CARBON OR LITEPLY BULKHEAD

CANOPY CUT LINE

SLOT FOR VELCRO & AILERON SERVO WIRES

CG POSITION
SPORT 3D

Li-Po BATTERY

Li-Po TRAY

SPEED CONTROLLER

EPP FILLETS

EPP SERVO TRAY

RX

RUDDER SERVO

ELEVATOR SERVO

ACROMASTER SPINNER

OUTER WING TUBES

EPP DOUBLERS

2 OFF REAR TURTLE DECK FILLETS
CHAMFER & SAND TO SHAPE

AIR EXIT HOLES (DUMMY EXHAUST STACKS)
FROM CARBON TUBE OFFCUTS

FUSELAGE JOINT/COWL LINE

MULTIPLEX ACROMASTER
UNDERCARRIAGE ASSEMBLY

HINGED ACCESS HATCH

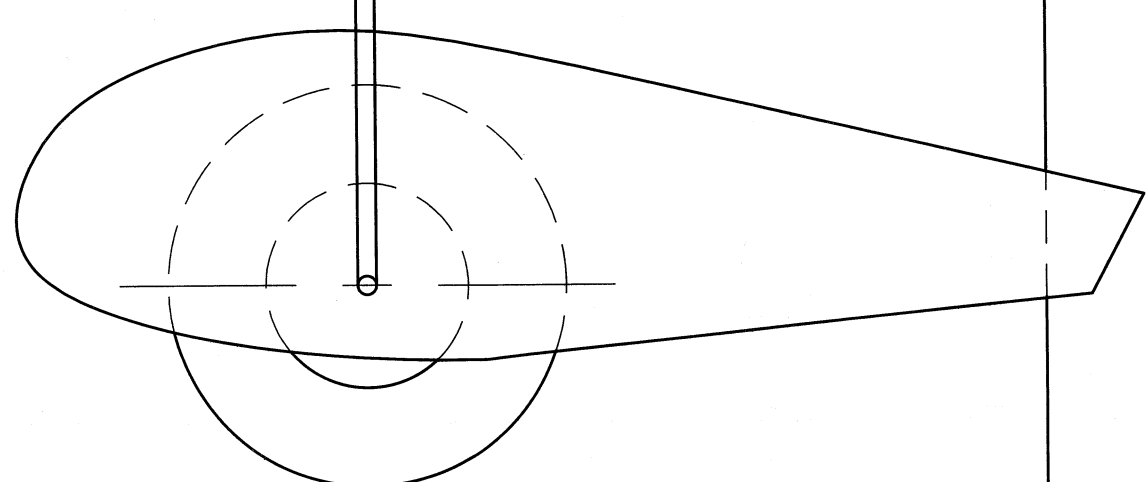
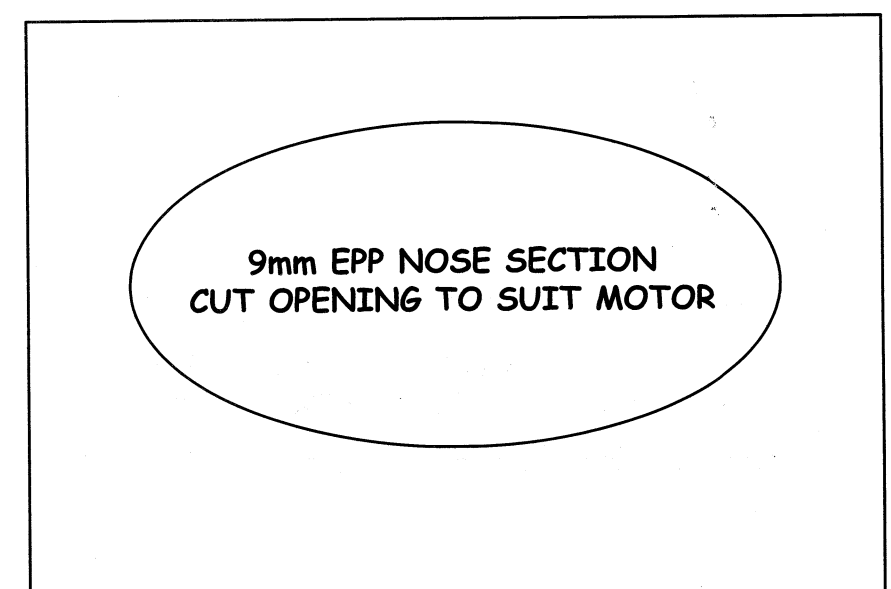
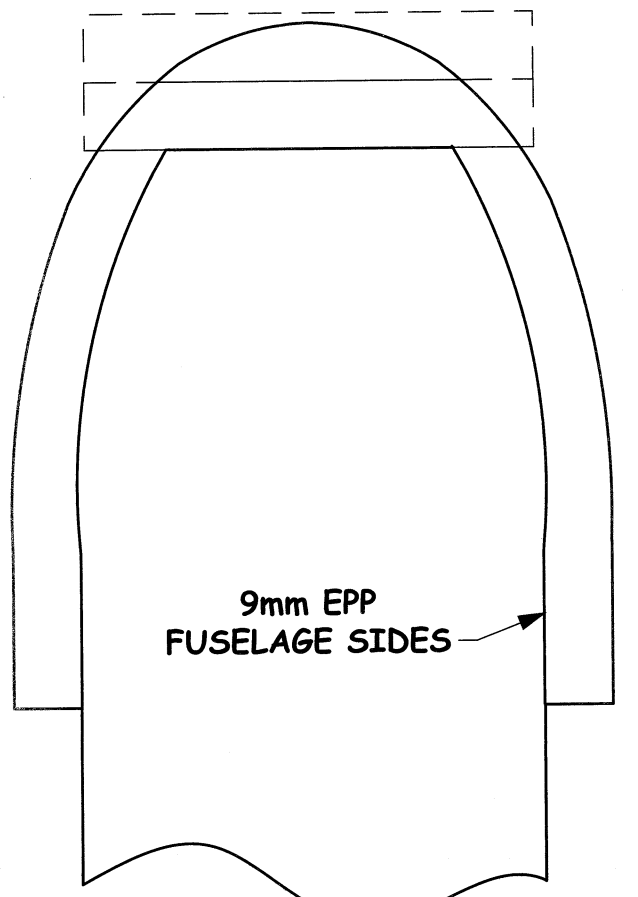

9mm EPP UPPER COWL

